

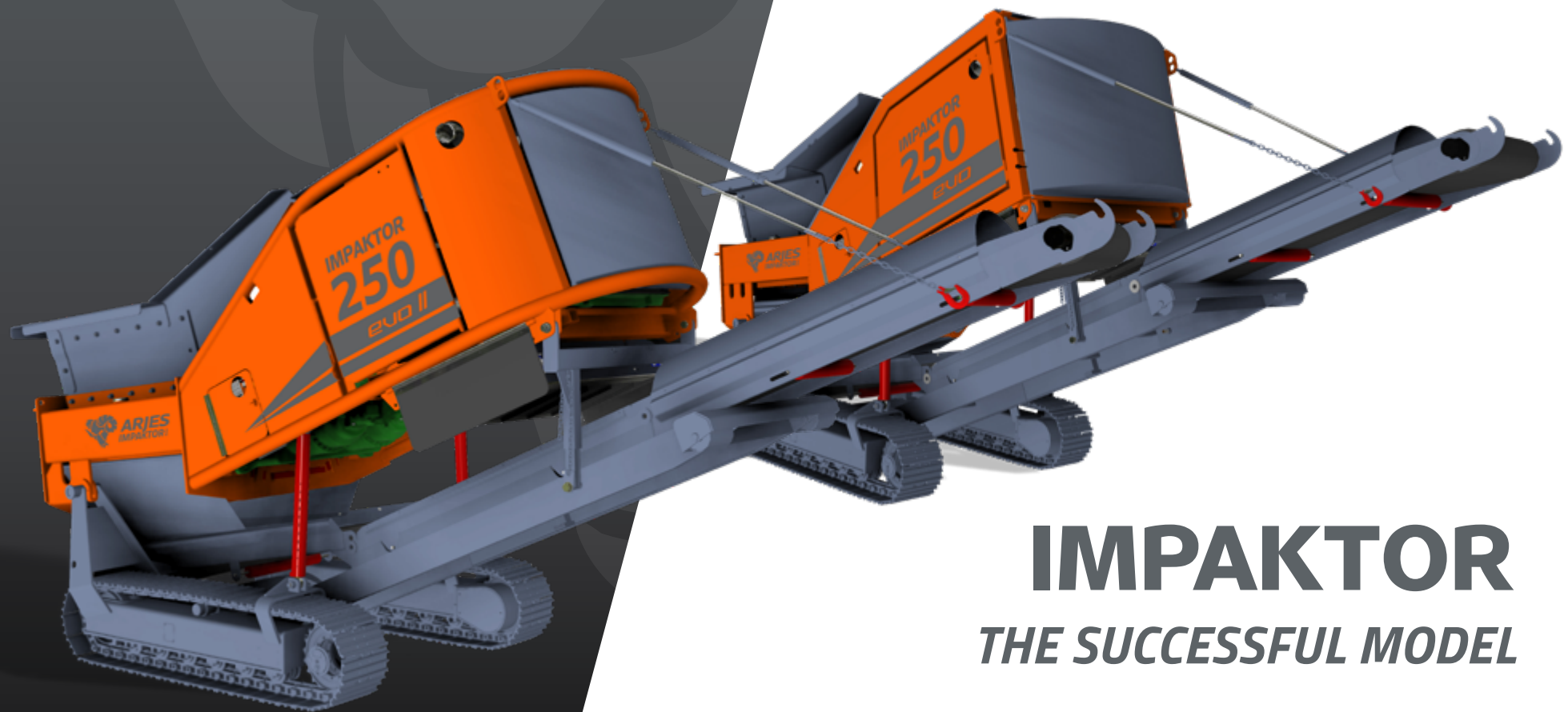

EN



ARJES
IMPAKTOR GmbH



IMPAKTOR
THE SUCCESSFUL MODEL

www.arjes-impaktor.de

OUR MOBILE SHREDDERS



STAR SHAFTS

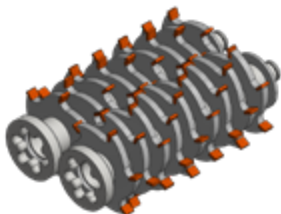



CONCRETE SHAFTS

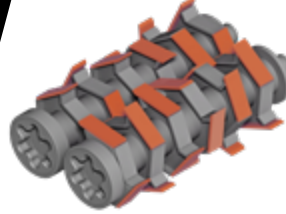

PADDEL SHAFTS



Fields of application IMPAKTOR

-  Waste Wood & Biomass
-  Household & Commercial Waste
-  Construction & Demolition Waste



ARJES IMPAKTOR

With the IMPAKTOR, entrepreneurs in the construction and demolition industry in particular will find an extremely compact, flexible and robust shredder at the best price-performance ratio. Relationship of the industry. But system operators who want to expand their operations with a compact shredder are also in the right place in this segment. The mobile shredder is characterized by its unique combination of chain drive and hook lift version, a revolutionary shaft quick-change system, an innovative SCU control and a shaft design that expands the machine's range of application many times over.

More than 1,500 units of the mobile twin-shaft shredder were delivered Already delivered over the last few years. Our goal is to be the successful brand To keep IMPAKTOR marketable and future-proof. For this reason, the twin-shaft shredder became the successor model in 2018 IMPAKTOR 250 evo was further developed and received the next significant evolutionary leap in 2022, the IMPAKTOR 250 evo II.

In addition to numerous possible uses for construction and demolition waste, the mobile shredder is also suitable for processing railway sleepers, rhizomes, old and fresh wood, tires, household and commercial waste and many other applications.



THROUGHPUT RATES*

Construction waste	Ø 80 – 100 t/h
Concrete / Asphalt	Ø 60 – 80 t/h
Waste wood	Ø 10 t/h
Biomass	Ø 20 t/h
Waste & Plastics	Ø 10 – 15 t/h

*Depends on the equipment of the shredder, the shaft configuration and the optimum material feed. The performance data given are average values without guarantee!

IMPAKTOR 250 evo *The highlights of the proven twin-shaft shredder*



WATER SPRINKLER

Included! Reduction of dust in the feeding area and at the discharge belt



REVERSING FAN

Optional! Self cleaning fan for ideal air circulation and dirt reduction in the engine compartment



COMPACT SCREEN

Optional! Easy separation of the material flow into two fractions (adjustable screen size)



SHREDDING UNIT

Large-volume hopper and two-shaft system incl- optimised **quick-change cassette**



NEW



CONTROL

Newly developed control and display for even more efficiency and user-friendliness



TRACK SYSTEM

Included! Guaranteed high mobility on uneven surfaces



MAGNET

Included! Height adjustable overband magnet for effective FE-seperation



DRIVE

Powerful **VOLVO PENTA** diesel engine for low consumption and maximum efficiency

POWERED BY
VOLVO PENTA

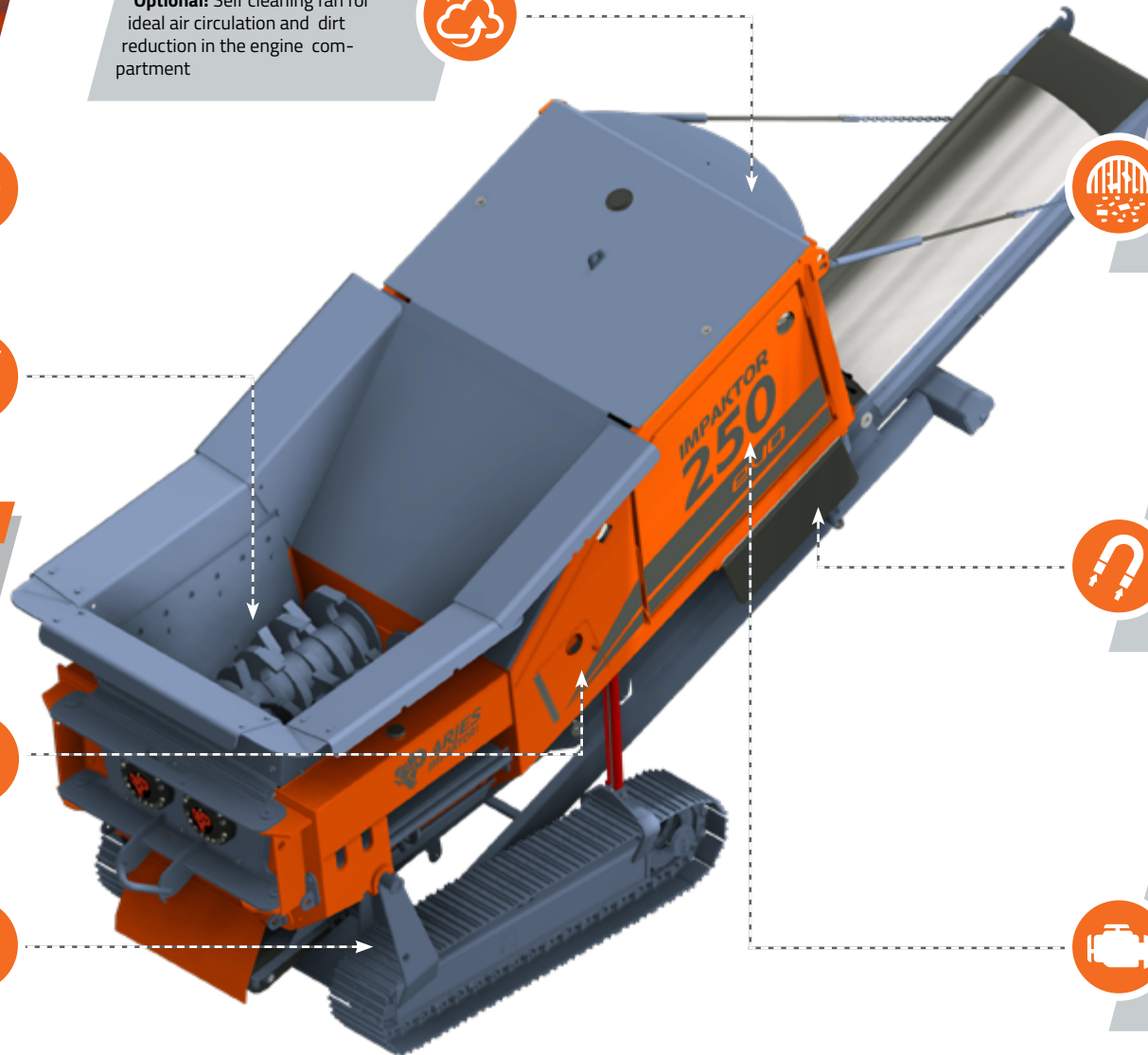

TECHNICAL DATA

DIMENSIONS

Version	Track system and hook lift
Length (mm)	7.700 / 7.300 (Transport)
Width (mm)	2.300 / 2.300 (Transport)
Height (mm)	3.500 / 2.800 (Transport)
Total weight (kg)	14.000

DRIVE	EU	US	ROW*
Engine (Volvo Penta)	TAD 581 VE	TAD 572 VE	TAD 551 VE
Emission standard	EU Stage V	EPA Tier 4f	Stage 3A
Power (kW / HP)	129 / 175	160 / 220	129 / 175
Fuel capacity (l)	360		
Gearbox	Bonfiglioli		

DISCHARGE BELT

Discharge height (mm)	3.450
Width (mm)	800
Included	Over-belt magnet and water sprinkler system

SHREDDING UNIT

Hopper volume (m ³)	2,25
Shaft length (mm)	1.500
Shaft diameter (mm)	680
Weight (kg / cassette)	2.000
Rotation speed (rpm)	11 – 35



Easy transportation to any work place

Due to the low basic weight and a hydraulically lowerable chassis, transportation is possible on a small truck or hook lift truck without special permissions.

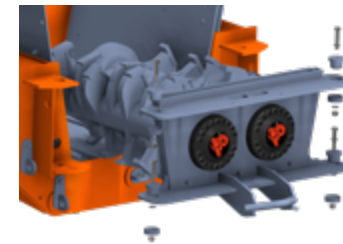

Quick change system for shafts

Easy installation and quick removal of shafts for easier maintenance, refurbishment and changing of shaft type, which increases more productivity.



Mechanically adjustable side combs

The side combs can be opened or closed, depending on material and customer requirements; decreasing the output size or increasing the throughput rate.

*Rest of the world (country-specific requirements)

IMPAKTOR 250 evo II *The highlights of the optimised successor model*



WATER SPRINKLER

Included! Reduction of dust in the feeding area and at the discharge belt



REVERSING FAN

Optional! Self cleaning fan for ideal air circulation and dirt reduction in the engine compartment



GRILLE

High air suction volume and optimal accessibility of the engine for service, maintenance and cleaning



SHREDDING UNIT

Large-volume hopper and two-shaft system incl. optimised **quick-change cassette**



NEW



CONTROL

Newly developed control and display for even more efficiency and user-friendliness



TRACK SYSTEM

Included! Guaranteed high mobility on uneven surfaces



DRIVE

Powerful **VOLVO PENTA** diesel engine for low fuel consumption and maximum efficiency

POWERED BY
VOLVO PENTA



COMPONENTS

Optional! Optimized shredding processes with the help of a sieve basket or bars



MAGNET

Included! Height adjustable overband magnet for effective FE-separation **including discharge container**



TECHNICAL DATA

DIMENSIONS

Version	Track system and hook lift
Length (mm)	7.700 / 7.300 (Transport)
Width (mm)	2.300 / 2.300 (Transport)
Height (mm)	3.900 / 2.550 (Transport)
Total weight (kg)	13.400

DRIVE	EU	US	ROW*
Engine (Volvo Penta)	TAD 581 VE	TAD 572 VE	TAD 551 VE
Emission standard	EU Stage V	EPA Tier 4f	Stage 3A
Power (kW / HP)	129 / 175	160 / 220	129 / 175
Fuel capacity (l)	300		
Gearbox	Bonfiglioli		

DISCHARGE BELT

Discharge height (mm)	3.200
Width (mm)	800
Included	Over-belt magnet, discharge container and water sprinkler system

SHREDDING UNIT

Hopper volume (m ³)	2,25
Shaft length (mm)	1.500
Shaft diameter (mm)	680
Weight (kg / cassette)	1.800
Rotation speed (rpm)	11 – 35



Reduced transport and working height

Due to the reduced transport height to approx. 255 cm, sea container collections are possible without dismantling the hopper walls and the maximum loading height for trucks is generally not exceeded.

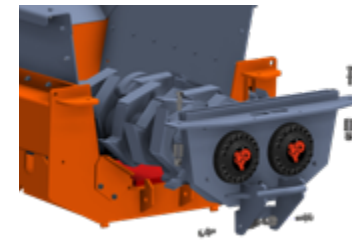

Revised quick-change cassette

The improved quick-change cassette ensures a significantly longer operating time as the pressure during the crushing process is no longer exerted on the fastening bolts, but on the entire machine.



Manually insertable waveform plates

By inserting or removing the plates, the gap width may be modified and thus the final grain size adjusted. In case of worn cutting blades, the plate can be rotated and reinserted several times.

*Rest of the world (country-specific requirements)

IMPAKTOR 250 E evo II *The stationary class*

MAGNET

Optinal! Height adjustable overband magnet for effective FE-seperation



SHREEDING UNIT

Large-volume hopper and two-shaft system incl. optimised **quick-change cassette**



NEW

COMPONENTS

Optional! Optimized shredding processes with the help of a sieve basket or bars



STATIONARY

Use as a stand-alone machine or optional integration into recycling systems according to customer requirements



DISCHARGE BELT

Optional! Conveyor belt for efficient material discharge according to customer requirements



NEW



CONTROL

Newly developed control and display for even more efficiency and user-friendliness



NEW

FREQUENCY CONVERTER

Included! With frequency inverter at no extra cost.



DRIVE

Powerful **electric motor** convinces with high efficiency and low energy costs

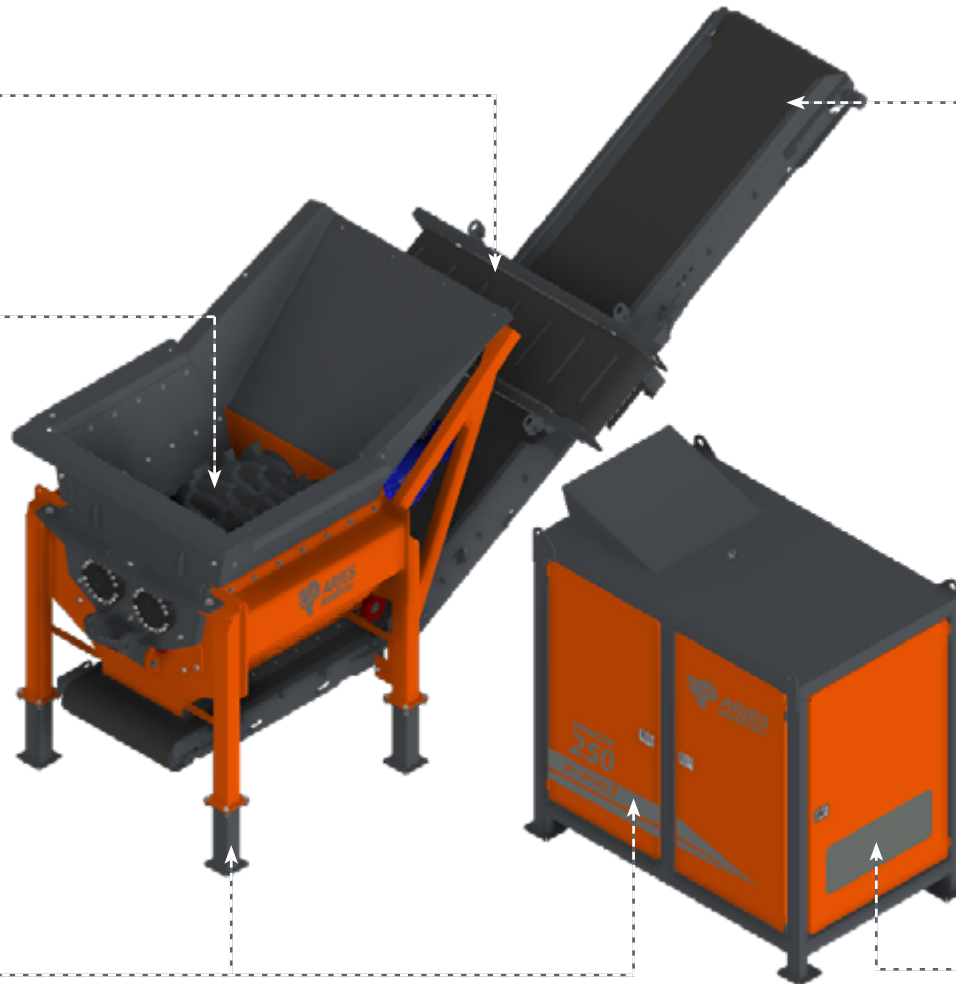

TECHNICAL DATA

DIMENSIONS

Execution Stationäry

Shredding unit

Length (mm) 3.300

Width (mm) 2.300

Height (mm) 3.200

Control unit

Length (mm) 2.600

Width (mm) 1.600

Height (mm) 2.700

Weight (kg) ca. 15.000

DRIVE

Motor type Elektric

Power (kW) 160

Gearbox Bonfiglioli

SHREDDING UNIT

Hopper Volume (m³) 2,25

Shaft length (mm) 1.500

Shaft diameter (mm) 680

Weight (kg / cassette) 1.800

Rotation speed (U / min) 11 – 35



Scan QR-Code and watch the IMPAKTOR 250 evo II in action!



Separate drive and Control unit

Due to the separate placement of the cerreduction and control unit, up to at a distance of approx. 8 m significantly less vibrations on the Steering. Dust and dirt are additionally reduced.

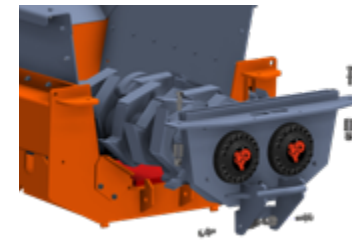

Revised quick-change cassette

The improved quick-change cassette ensures a significantly longer operating time as the pressure during the crushing process is no longer exerted on the fastening bolts, but on the entire machine.



Manually insertable waveform plates

By inserting or removing the plates, the gap width may be modified and thus the final grain size adjusted. In case of worn cutting blades, the plate can be rotated and reinserted several times.

IMPORTANT COMPONENTS *Optimized performance*

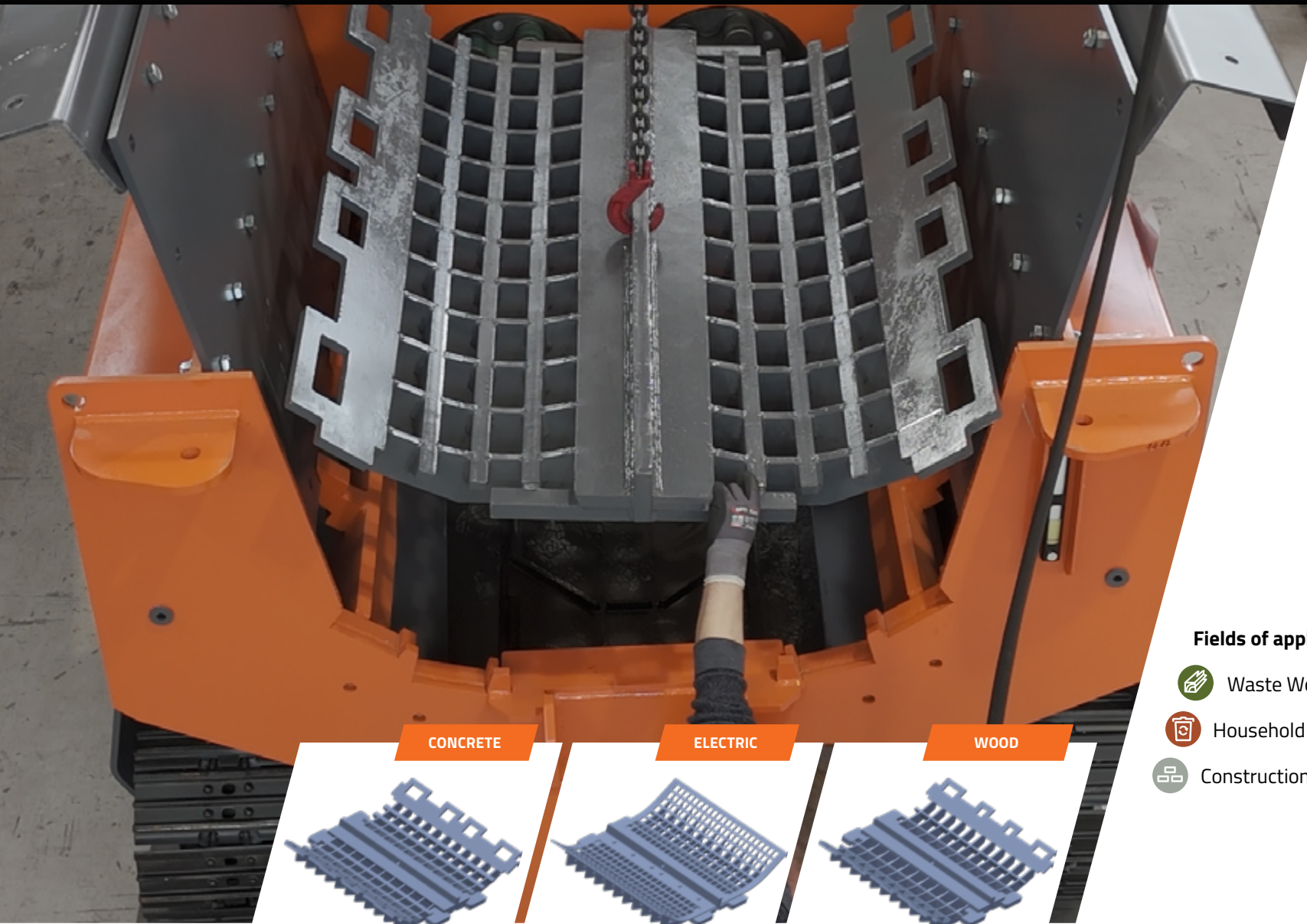

CONCRETE

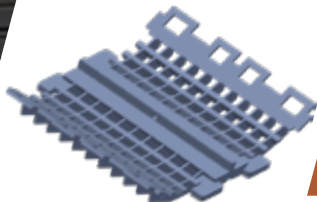

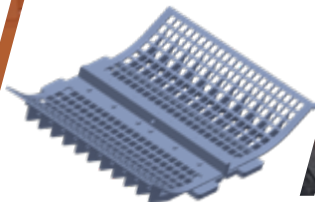

ELECTRIC

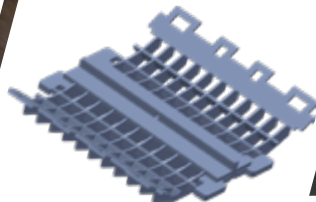

WOOD



Fields of application **IMPAKTOR**

-  Waste Wood & Biomass
-  Household & Commercial Waste
-  Construction & Demolition Waste

STRAINER BASKET

The screen basket is a key component in our IMPAKTOR models, designed to classify and sort materials into different sizes. By selecting different mesh sizes, the customer has the option of adjusting the particle size as required.

Available mesh sizes:

- Wood 100x110mm
- Concrete 60x110mm
- Electric (30x30mm / 40x40mm / 50x50mm - customer specification)

As the material passes through the shredding process, the screen basket separates larger pieces from the end product and enables precise size reduction of the material. By using a screen basket in our IMPAKTOR models, the particle size of the end product can be controlled and adjusted to the exact requirements of the customer or application. This results in improved product quality and consistency. In addition, the screen basket helps to increase the efficiency of the shredding process by ensuring that only the desired end product is further processed, while larger or unwanted particles are sorted out.

Overall, the screen basket plays a decisive role in optimizing the performance and productivity of shredding systems by enabling precise and efficient material processing.

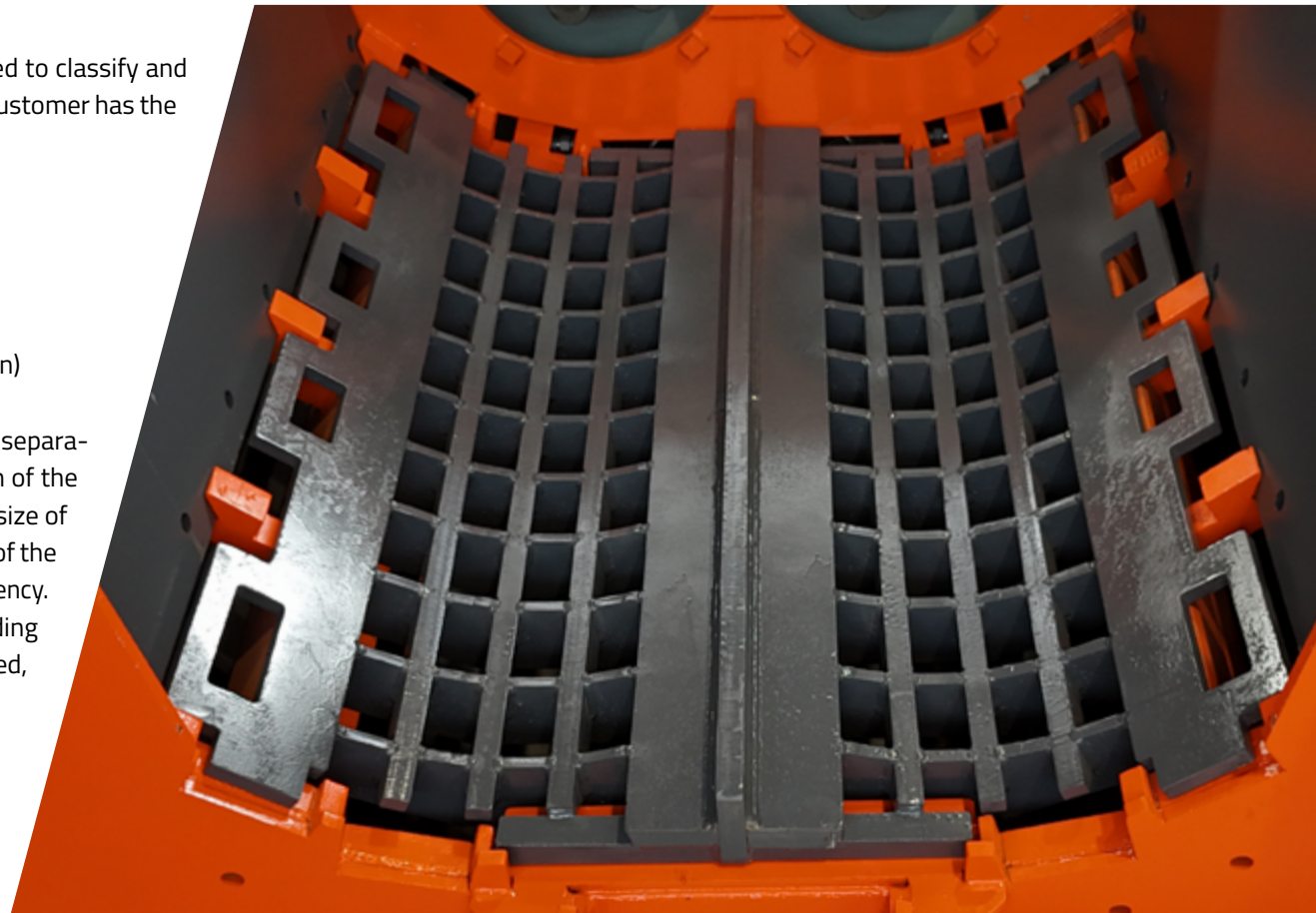



ARJES
IMPAKTOR
GmbH

ARJES IMPAKTOR GmbH

Werkspatz 2

D-36433 Leimbach

✉ info@arjes-impaktor.de

🌐 www.arjes-impaktor.de

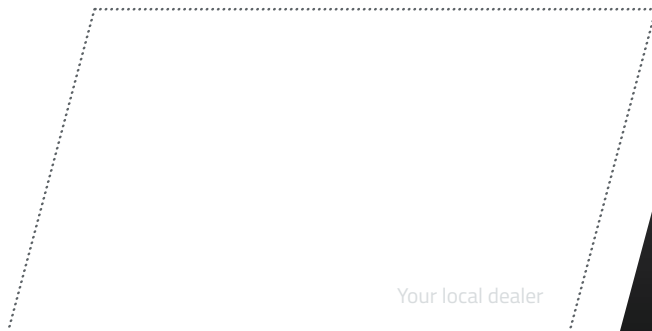

Your local dealer

Disclaimer: We reserve the right to make technical changes, misprints and errors. All specifications refer to the standard version without optional features. Status: August 2023



5 CONVINCING ARGUMENTS FOR OUR SUCCESSFUL MODEL

- 1 Best price-performance ratio in its class**
incl. standard attachments (e.g. water sprinkler system, magnet etc.)
- 2 Largest range of applications**
Processing of many types of material with the toughest requirements (such as c&d debris, concrete, tyres, waste wood, household and industrial waste, etc.)
- 3 Revolutionary shaft quick-change system**
Shortens maintenance times, refurbishment and changing different shaft types for uninterrupted operation
- 4 Maximum mobility in every situation**
Track system and hooklift / multilift included as standard
- 5 Innovative SCU plug-and-play control**
Predefined shredding programs that control rotation and speed of shafts for user-friendly operability